

N904 Series

Liquid Ring Vacuum Pumps

Models: N904L, N904M, N904P, N904R, N904S, N904T, N904U



Description: Single-Stage Liquid Ring Vacuum Pump

Type: Dual Cone

Models: N904-L, M, P, R, S, T & U

Power Range: 30-900 HP

Capacity Range: 2,200-17,200 CFM

Max Vacuum: 27.5" Hg

Max Compression: 14.7 psia

OVERVIEW

Our N904 series are designed as drop-in replacements for classic Nash* 904 / 905 vacuum pumps. These vacuum pumps rotate at relatively slow speeds for higher reliability, less wear, and lower power consumption. The N904 is ideal for pulp & paper, geothermal power generation, and other high reliability high capacity applications. We offer the L through U versions with capacities ranging from 2,200 to 17,200 CFM.

CONSTRUCTION

Our 30-900 HP pulp and paper vacuum pumps are designed as [drop-in replacements](#) for classic 904 vacuum pumps. These high efficiency 27.5" HgV vacuum pumps rotate at relatively slow speeds for higher reliability, less wear, and lower power consumption. The N904 is ideal for pulp & paper, geothermal power generation, and other high reliability high [capacity applications](#). We offer the L through U versions with capacities ranging from 2,200 to 17,200 CFM.



FEATURES

- Drop-in replacement for classic Nash* 904 series
- Standard construction is Cast Iron with Teflon Packing.
- Optional 304 or 316 Stainless Steel construction.
- Optional factory installed mechanical seals
- Parts and repair kits available to fit Nash* 904 / 905 Series
- Available in bare pump, direct drive or V-belt systems
- 2-year factory warranty. Against manufacturer's defects.

NOTES

NES Company is proud to offer our single stage/single cone N904 Series liquid ring vacuum pumps. These new pumps have been designed to be drop-in replacements for classic Nash* 904 / 905 Series pumps. NES pumps are factory performance tested and include a 2-year warranty.

N904 Series



Liquid Ring Vacuum Pumps

Models: N904L, N904M, N904P, N904R, N904S,
N904T, N904U

GENERAL TECHNICAL DATA

Model	Max Vacuum [”Hg]	Speed [RPM]	Capacity [CFM] @ 15” Hg	Motor Power [HP]	Inlet [in]	Discharge [in]	Seal Water Usage [GPM]	Seal Water Size [in]	Pump Weight Dry [lbs]	
								Single / Double extended Shaft	Cast Iron	Stainless Steel
N904L1	20	277	2680	125	10 FL	8 FL	24 - 32	1/2 NPT	7900	8650
		300	2995	125						
		327	3200	150						
		360	3600	200						
		400	4000	200						
		429	4280	250						
		450	4450	250						
		500	4950	300						
N904L2	26	300	2800	125	10 FL	8 FL	32 - 48	1/2 NPT	7900	8650
		327	3200	150						
		360	3600	200						
		400	4000	150						
		429	4300	250						
		450	4500	250						
		500	4900	300						
		N904M1	20	277						
300	3600			150						
327	4990			200						
360	4400			200						
400	4800			250						
429	5180			250						
450	5400			300						
500	5990			350						
N904M2	26	300	3550	150	10 FL	8 FL	40 - 72	1/2 NPT	8800	9575
		327	3950	200						
		360	4300	200						

N904 Series



Liquid Ring Vacuum Pumps

Models: N904L, N904M, N904P, N904R, N904S,
N904T, N904U

		400	4850	250						
		429	5100	250						
		450	5400	300						
		500	5990	350						
N904P1	20	225	4250	200	12 FL	10 FL	35 - 42	1/2 NPT	13950	15025
		240	4680	200						
		257	5080	200						
		277	4550	250						
		300	5990	250						
		327	5410	350						
		360	7000	400						
		400	7800	400						
N904P2	24.5	240	4700	200	12 FL	10 FL	53 - 70	1/2 NPT	13950	15025
		257	5100	250						
		277	5500	250						
		300	5850	300						
		327	6600	300						
		360	7100	350						
		400	7800	400						
N904P3	27.5	277	5200	200	12 FL	10 FL	48 - 112	1/2 NPT	13950	15025
		300	5600	250						
		327	6200	250						
		360	6480	300						
		400	7200	400						
N904R1	20	225	5200	200	12 FL	10 FL	45 - 53	1/2 NPT	15750	16950
		240	5600	250						
		257	6000	300						
		277	6600	300						
		300	7100	350						
		327	7700	400						
		360	8480	400						
		400	9150	400						

N904 Series



Liquid Ring Vacuum Pumps

Models: N904L, N904M, N904P, N904R, N904S,
N904T, N904U

N904R2	24.5	240	5600	250	12 FL	10 FL	60 - 80	1/2 NPT	15750	16950
		257	6100	250						
		277	6600	250						
		300	7100	300						
		327	7700	350						
		360	8500	400						
		400	9450	400						
N904R3	27.5	277	5700	250	12 FL	10 FL	50 - 130	1/2 NPT	15750	16950
		300	6200	300						
		327	6800	350						
		350	7200	400						
		400	7610	400						
N904S1	20	180	6020	250	14 FL	12 FL	55 - 65	1/2 NPT	21700	23350
		200	6810	300						
		215	7400	300						
		225	7780	350						
		240	8350	400						
		257	8880	400						
		277	9450	400						
		300	10180	400						
		327	10900	400						
N904S2	24.5	200	6800	300	14 FL	12 FL	75 - 100	1/2 NPT	21700	23350
		215	7400	300						
		225	7760	350						
		240	8230	350						
		257	8995	400						
		277	9500	400						
		300	10250	400						
		327	11200	400						

N904 Series



Liquid Ring Vacuum Pumps

Models: N904L, N904M, N904P, N904R, N904S,
N904T, N904U

N904S3	27.5	240	7600	300	14 FL	12 FL	56 - 150	1/2 NPT	21700	23350
		257	8400	350						
		277	9170	400						
		300	10050	400						
		327	10960	400						
N904T1	19	180	6850	300	14 FL	12 FL	60 - 72	1/2 NPT	23500	25250
		200	7800	300						
		215	8400	350						
		225	8800	350						
		240	9400	400						
		257	10000	400						
		277	10700	400						
		300	11400	400						
		327	12200	400						
N904T2	24.5	200	7800	350	14 FL	12 FL	85 - 115	1/2 NPT	23500	25250
		215	8400	350						
		225	8850	400						
		240	9500	400						
		257	10100	400						
		277	10800	400						
		300	11600	400						
		327	12550	400						
N904T3	27.5	240	8700	3450	14 FL	12 FL	60 - 170	1/2 NPT	23500	25250
		257	9400	350						
		277	10000	400						
		300	10800	400						
		327	11900	400						

N904 Series



Liquid Ring Vacuum Pumps

Models: N904L, N904M, N904P, N904R, N904S,
N904T, N904U

N904U1	19	160	9300	350	16 FL	14 FL	84 - 100	2 NPT	33500	-
		180	10450	400						
		200	12200	400						
		215	13200	400						
		225	13500	400						
		240	14400	400						
		257	15400	400						
		277	16500	400						
N904U2	24.5	180	11100	400	16 FL	14 FL	120 - 160	2 NPT	33500	-
		200	12400	400						
		215	13000	400						
		225	13600	400						
		240	14400	400						
		257	15400	400						
		277	16300	400						

N904 Series

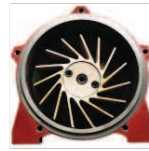

NES
COMPANY

Liquid Ring Vacuum Pumps

Models: N904L, N904M, N904P, N904R, N904S,
N904T, N904U

Variation Table

Variations Table	Particulars
Metallurgy	Standard Cast Iron
	Stainless Steel 304 cladded
	Stainless Steel 316L cladded
	Duplex Steel cladded
	Bronze cladded
Direction	Clockwise
	Counter- Clockwise Rotation
Purpose	Vacuum Pump
	Compressor
Integrated Gear	Available as integrated and non-integrated
Shaft	Single extended
	Double extended
Sealing	Standard Available as Gland Packing
	Available with Single Seal
	Available with Single Cartridge Seal
	Available with Dual Cartridge Seal and Seal Pot
Configuration	Once Through
	Partial Recovery
	Full Sealant Recovery
Other System Configuration	Simplex
	Duplex
	Triplex
	Quadruplex

N904 Series

Liquid Ring Vacuum Pumps

Models: N904L, N904M, N904P, N904R, N904S,
N904T, N904U



Vacuum pump Length, Height, Breadth, Key way, Shaft diameter

Model	Length (Inches)		Length (Inches)		Breadth (Inches)		Key Way (Inches)	Shaft diameter (Inches)
	Single extended	Double extended	Single extended	Double extended	Single extended	Double extended		
N904L1 N904L2	86	96.63	61.13	61.13	49	49	1 - 1/4 x 63/100	5 ± 0 - 1/1000
N904M1 N904M2 	94	104.53	61.13	61.13	49	49	1 - 1/4 x 63/100	5 ± 0 - 1/1000
N904P1 N904P2 N904P3	100.75	113.75	70.88	70.88	58.25	58.25	1 - 3/4 x 3/4	3-1/2 ± 0 - 1/1000
N904R1 N904R2 N904R3	109.75	122.75	70.88	70.88	58.25	58.25	1 - 3/4 x 3/4	3-1/2 ± 0 - 1/1000
N904S1 N904S2 N904S3	117.5	132.5	82.63	82.63	69.38	69.38	1 - 3/4 x 3/4	15/2 ± 0 - 1/1000
N904T1 N904T2 N904T3	124.5	139.5	82.63	82.63	69.5	69.5	1 - 3/4 x 3/4	15/2 ± 0 - 1/1000
N904U1 N904U2	134.5	153	95.25	95.25	75	75	5/2 X 7/8	39/4 ± 0 - 1/1000

Application table

Applications
Pulp and paper
Geothermal power
Chemical processing
Sugar Processing- carbonation
Brewery
Steel Making Process

N904 Series

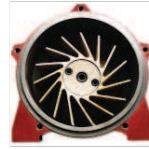

NES COMPANY

Liquid Ring Vacuum Pumps

Models: N904L, N904M, N904P, N904R, N904S,
N904T, N904U

Exploded View P, R, S, T

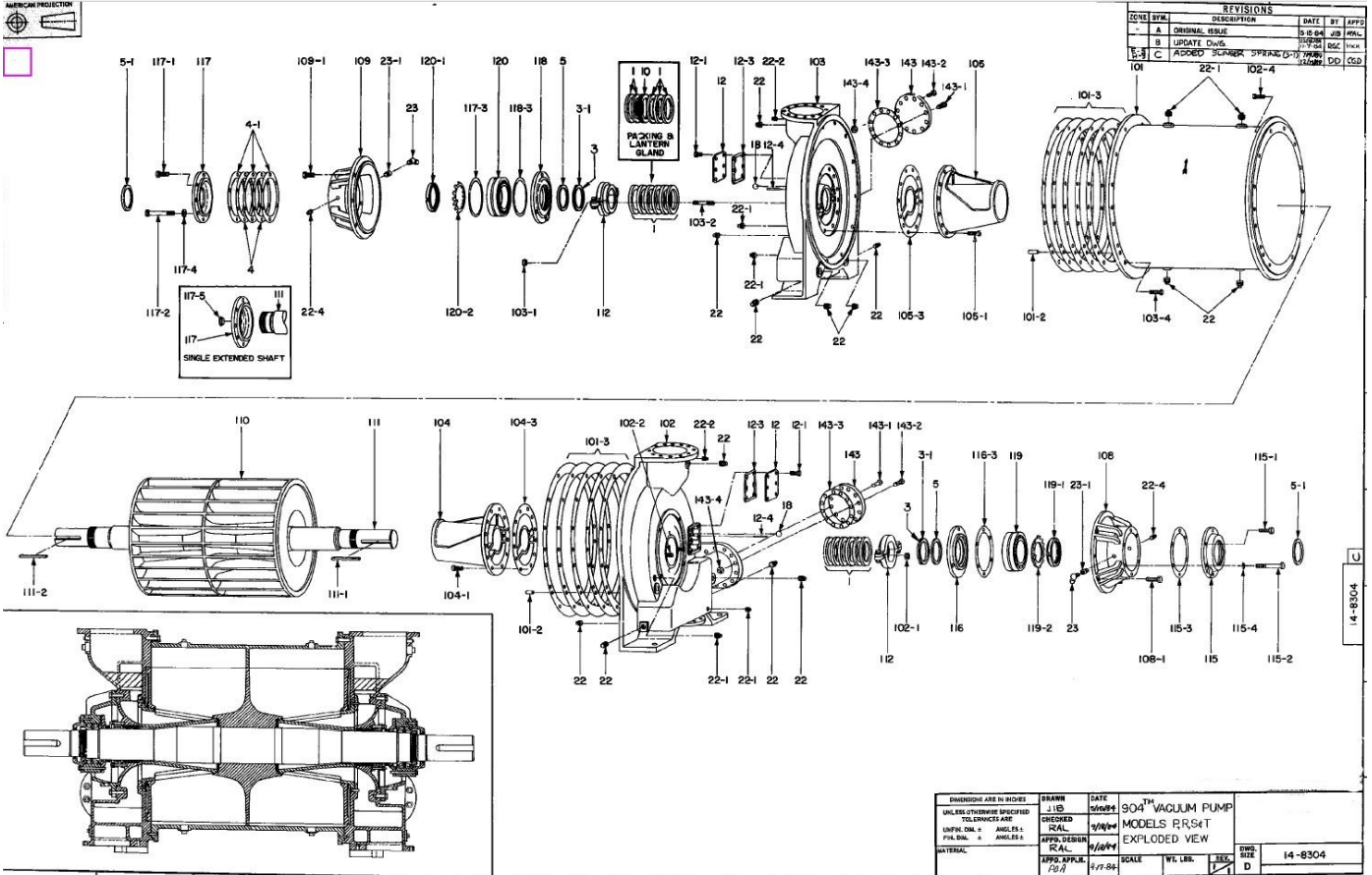

N904 Series

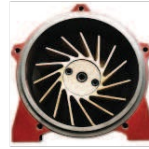

NES COMPANY

Liquid Ring Vacuum Pumps

Models: N904L, N904M, N904P, N904R, N904S,
N904T, N904U

Exploded View U2

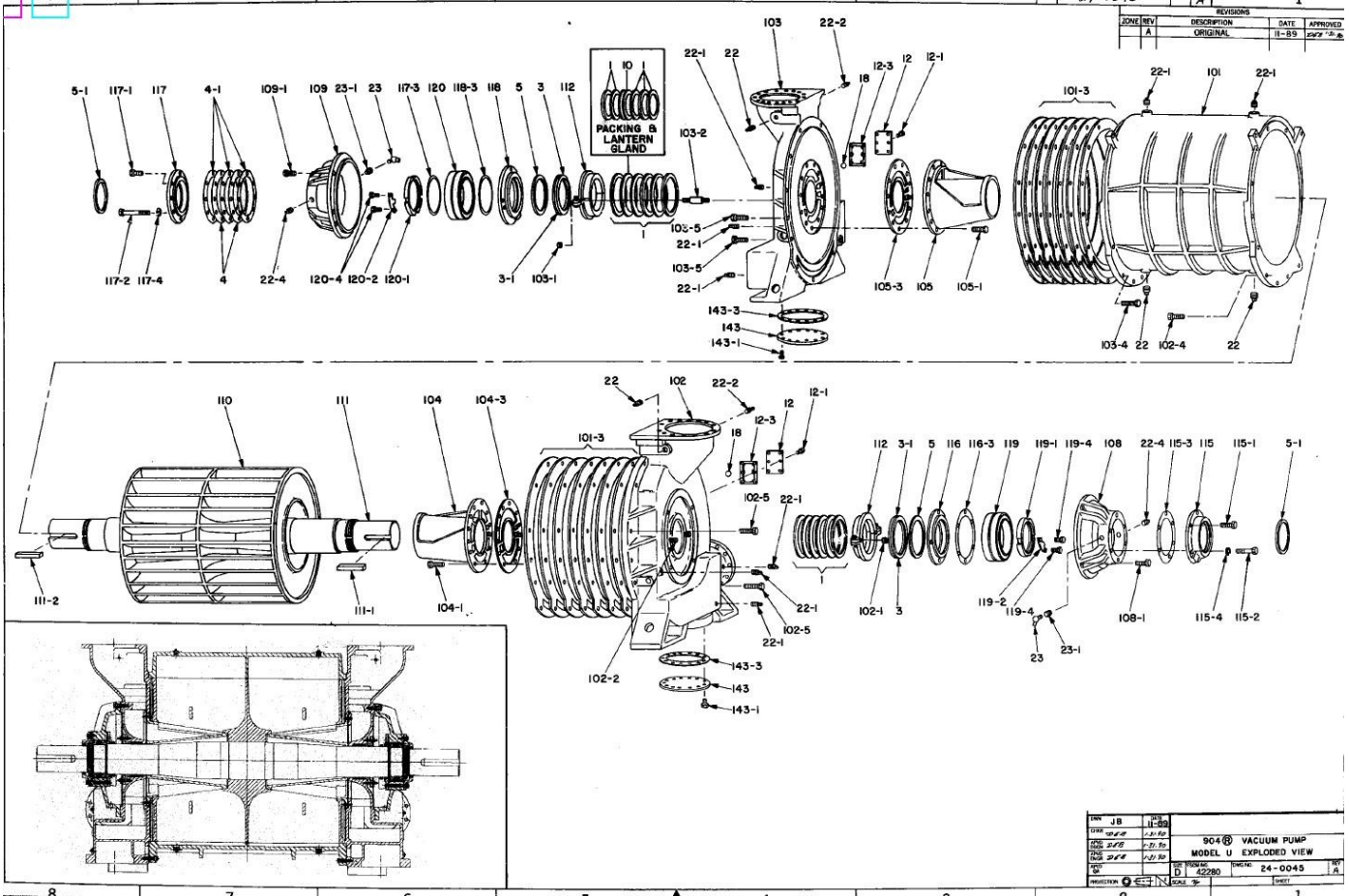

N904 Series

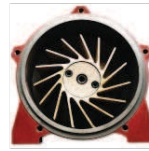

NES COMPANY

Liquid Ring Vacuum Pumps

Models: N904L, N904M, N904P, N904R, N904S,
N904T, N904U

Composite Curve Volume L1, M1, P1, R1, S1, T1, U1

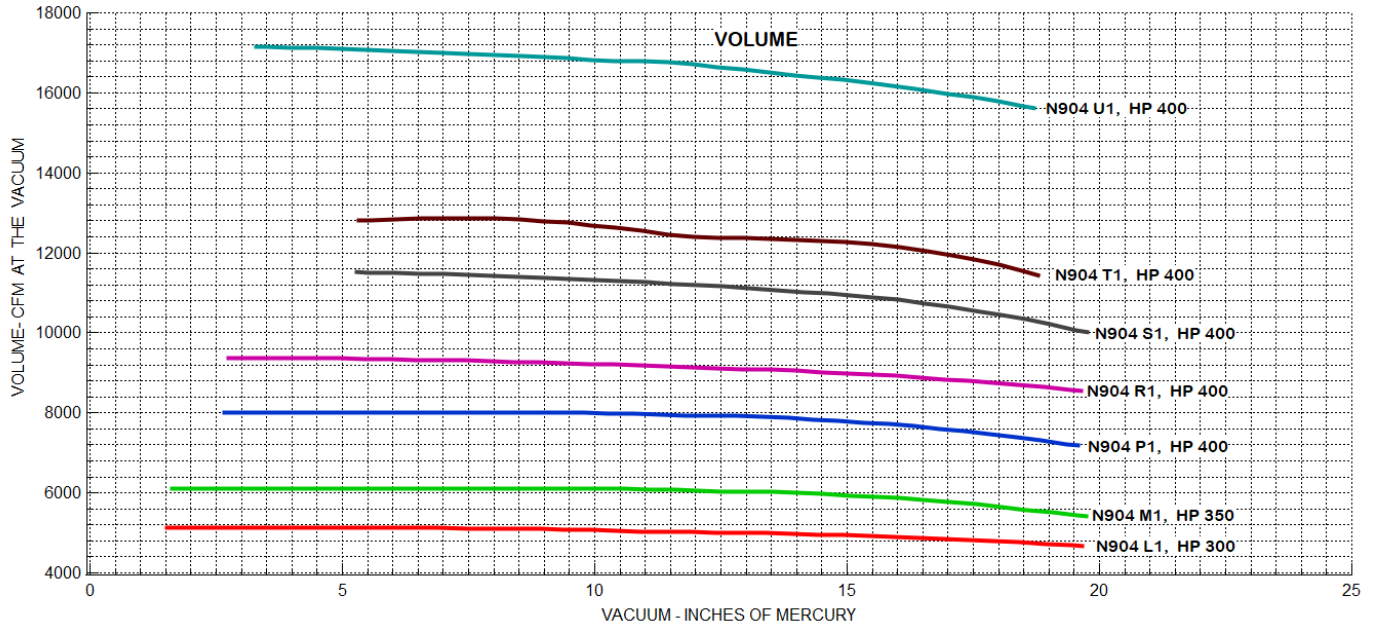

N904 Series

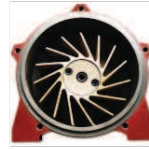

Liquid Ring Vacuum Pumps

Models: N904L, N904M, N904P, N904R, N904S,
N904T, N904U

Composite Curve Volume L2, M2, P2, R2, S2, T2, U2

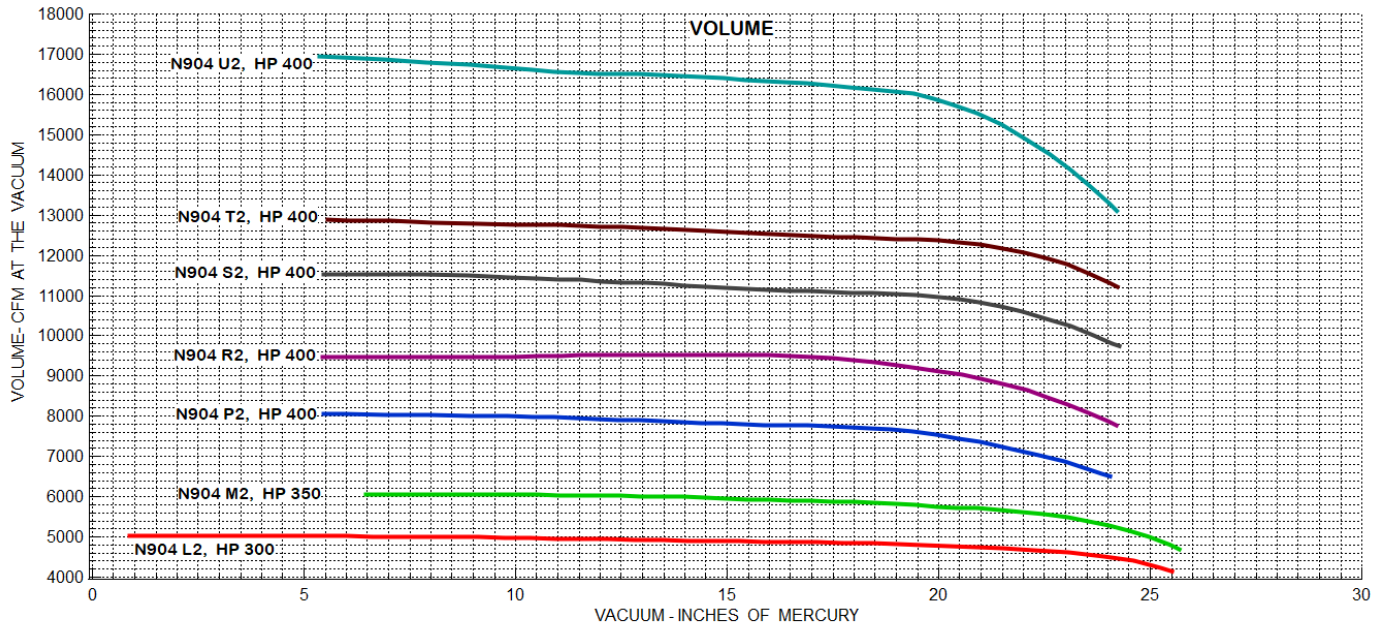

N904 Series

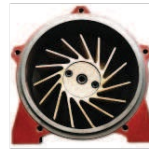

NES COMPANY

Liquid Ring Vacuum Pumps

Models: N904L, N904M, N904P, N904R, N904S,
N904T, N904U

Composite Curve Volume P3, R3, S3, T3

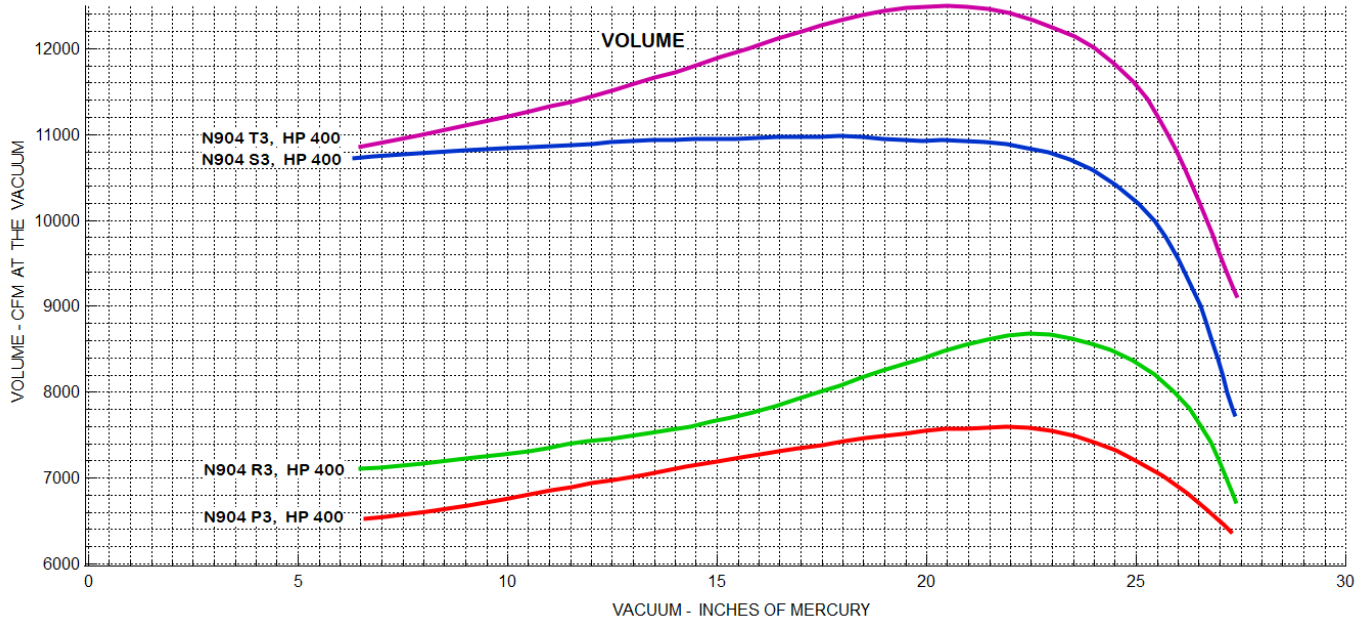

N904 Series

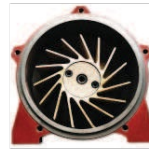

NES COMPANY

Liquid Ring Vacuum Pumps

Models: N904L, N904M, N904P, N904R, N904S,
N904T, N904U

Composite Curve Power L1, M1, P1, R1, S1, T1, U1

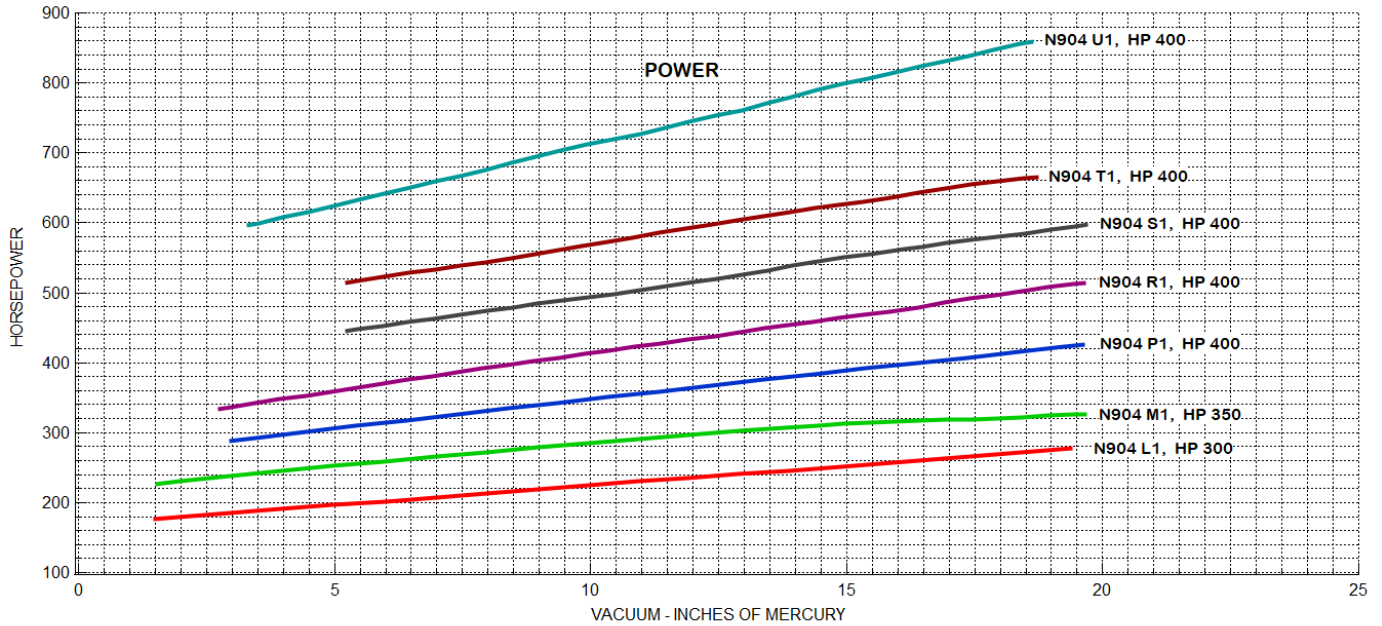

N904 Series

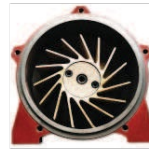

NES COMPANY

Liquid Ring Vacuum Pumps

Models: N904L, N904M, N904P, N904R, N904S,
N904T, N904U

Composite Curve Power L2, M2, P2, R2, S2, T2, U2

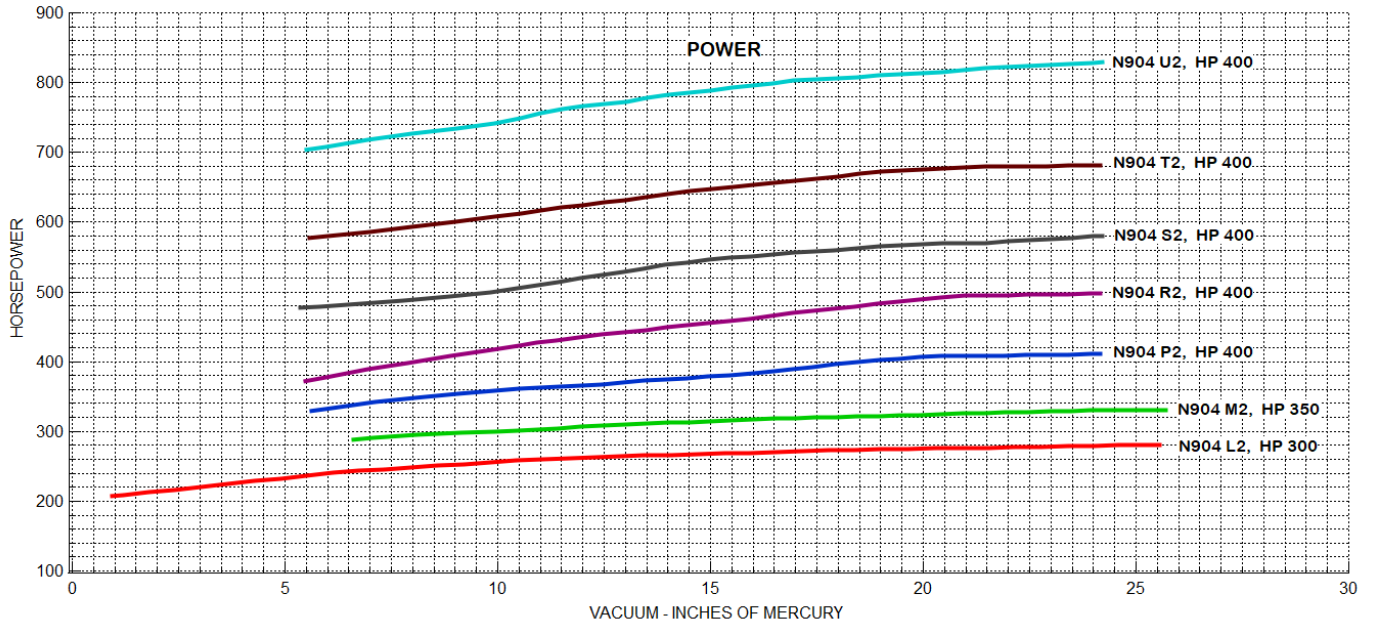

N904 Series

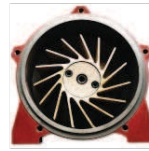

NES COMPANY

Liquid Ring Vacuum Pumps

Models: N904L, N904M, N904P, N904R, N904S,
N904T, N904U

Composite Curve Power P3, R3, S3, T3

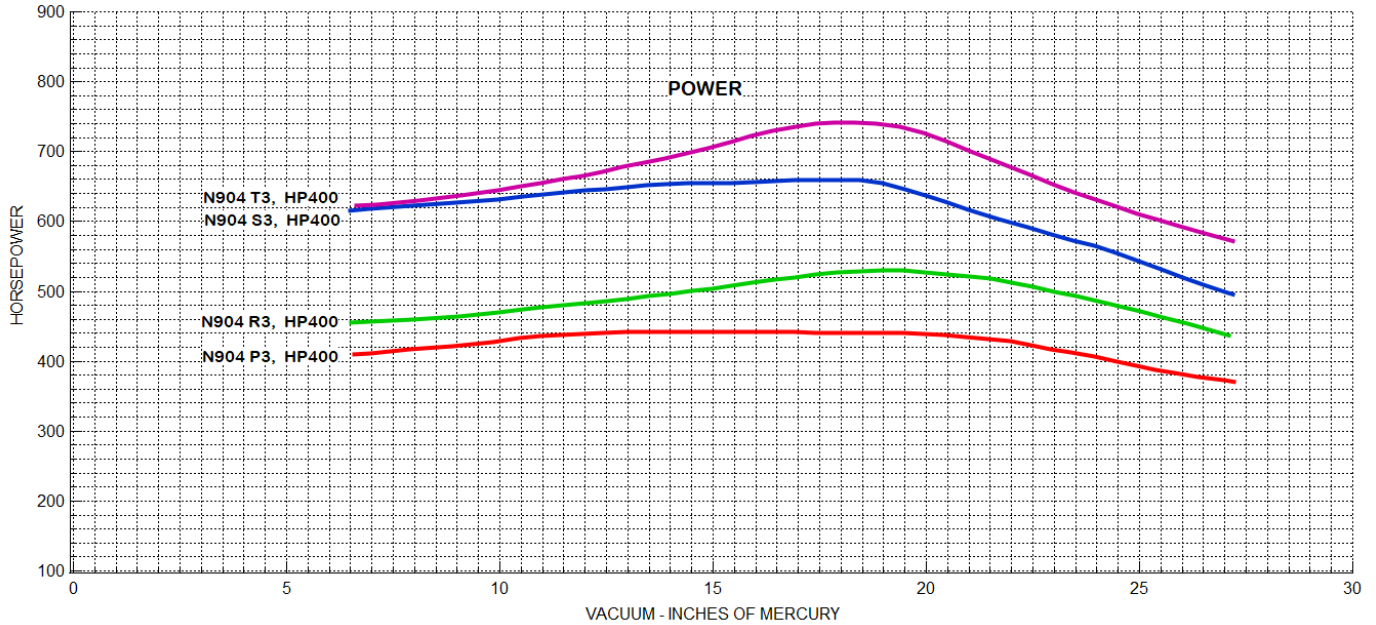

N904 Series

Liquid Ring Vacuum Pumps

Models: N904L, N904M, N904P, N904R, N904S,
N904T, N904U

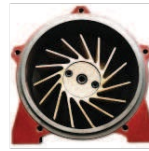

NES COMPANY

Additional accessories.

Name of the model of vacuum pump/compressor	Inlet separator model No	Discharge separator model No	Metallurgy	Orientation
N904L	VPSI-10 Grade II	VPSS-8 Grade II	Carbon steel, stainless 304, stainless steel 316, stainless steel 316 L	Available normal and reverse orientation
N904M	VPSI-10 Grade II	VPSS-8 Grade II	Carbon steel, stainless 304, stainless steel 316, stainless steel 316 L	Available normal and reverse orientation
N904P	VPSI-12 Grade II	VPSS-10 Grade II	Carbon steel, stainless 304, stainless steel 316, stainless steel 316 L	Available normal and reverse orientation
N904R	VPSI-12 Grade II	VPSS-10 Grade II	Carbon steel, stainless 304, stainless steel 316, stainless steel 316 L	Available normal and reverse orientation
N904S	VPSI-14 Grade II	VPSS-12 Grade II	Carbon steel, stainless 304, stainless steel 316, stainless steel 316 L	Available normal and reverse orientation
N904T	VPSI-14 Grade II	VPSS-12 Grade II	Carbon steel, stainless 304, stainless steel 316, stainless steel 316 L	Available normal and reverse orientation
N904U	VPSI-16 Grade II	VPSS-14 Grade II	Carbon steel, stainless 304, stainless steel 316, stainless steel 316 L	Available normal and reverse orientation

N904 Series

Liquid Ring Vacuum Pumps

Models: N904L, N904M, N904P, N904R, N904S,
N904T, N904U

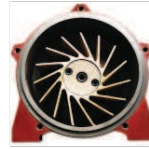

NES COMPANY

Model Number	Inlet Manifold		Outlet Manifold		Notes
	Inlet (inches)	Outlet (inches)	Inlet (inches)	Outlet (inches)	
N904L	10"	14"	8"	12"	Available in Carbon Steel, Stainless Steel 304 and Stainless Steel 316
N904M	10"	14"	8"	12"	Available in Carbon Steel, Stainless Steel 304 and Stainless Steel 316
N904P	12"	16"	10"	14"	Available in Carbon Steel, Stainless Steel 304 and Stainless Steel 316
N904R	12"	18"	10"	14"	Available in Carbon Steel, Stainless Steel 304 and Stainless Steel 316

N904 Series

Liquid Ring Vacuum Pumps

Models: N904L, N904M, N904P, N904R, N904S,
N904T, N904U

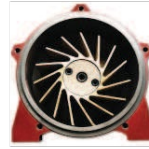

NES
COMPANY

N904S	14"	20"	12"	16"	Available in Carbon Steel, Stainless Steel 304 and Stainless Steel 316
N904T	14"	20"	12"	16"	Available in Carbon Steel, Stainless Steel 304 and Stainless Steel 316
N904U	14"	24"	14"	20"	Available in Carbon Steel, Stainless Steel 304 and Stainless Steel 316